

Product data sheet

Specifications



TeSys Deca Manual Starter and Protector, thermal magnetic circuit protector, push buttons, 0.16...0.25 A, screw clamp terminals

GV2ME02

Product availability: Stock - Normally stocked in distribution facility

Main

Range	TeSys Deca
Product name	TeSys GV2
Product or Component Type	Motor circuit breaker
Device short name	GV2ME
Device Application	Motor protection
Trip unit technology	Thermal-magnetic

Complementary

Poles description	3P
Network type	AC
Utilisation category	Category A IEC 60947-2 AC-3 IEC 60947-4-1 AC-3e IEC 60947-4-1
Network frequency	50/60 Hz IEC 60947-2
Motor power kW	0.06 kW 400/415 V AC 50/60 Hz
Breaking capacity	100 kA Icu 230/240 V AC 50/60 Hz IEC 60947-2 100 kA Icu 400/415 V AC 50/60 Hz IEC 60947-2 100 kA Icu 440 V AC 50/60 Hz IEC 60947-2 100 kA Icu 500 V AC 50/60 Hz IEC 60947-2 100 kA Icu 690 V AC 50/60 Hz IEC 60947-2
[Ics] rated service short-circuit breaking capacity	100 % 230/240 V AC 50/60 Hz IEC 60947-2 100 % 400/415 V AC 50/60 Hz IEC 60947-2 100 % 440 V AC 50/60 Hz IEC 60947-2 100 % 500 V AC 50/60 Hz IEC 60947-2 100 % 690 V AC 50/60 Hz IEC 60947-2
Control Type	Push-button
Line Rated Current	0.25 A
Thermal protection adjustment range	0.16...0.25 A IEC 60947-2
Magnetic tripping current	3.08 A
[Ith] conventional free air thermal current	0.25 A IEC 60947-2
[Ue] rated operational voltage	690 V AC 50/60 Hz IEC 60947-2
[Ui] rated insulation voltage	690 V AC 50/60 Hz IEC 60947-2
[Uimp] rated impulse withstand voltage	6 kV IEC 60947-2
Phase failure sensitivity	Yes IEC 60947-4-1
Suitability for isolation	Yes IEC 60947-1

Price is "List Price" and may be subject to a trade discount – check with your local distributor or retailer for actual price.

Power dissipation per pole	2.5 W
Mechanical durability	100000 cycles
Electrical durability	100000 cycles AC-3 415 V In 100000 cycles AC-3e 415 V In
Rated duty	Uninterrupted IEC 60947-4-1
Connections - terminals	Power circuit screw clamp terminal 2 0.002...0.009 in ² (1...6 mm ²)solid Power circuit screw clamp terminal 2 0.002...0.009 in ² (1.5...6 mm ²)flexible without cable end Power circuit screw clamp terminal 2 0.002...0.006 in ² (1...4 mm ²)flexible with cable end
Tightening torque	15.05 lbf.in (1.7 N.m) screw clamp terminal
Fixing mode	35 mm symmetrical DIN rail clipped Panel screwed with adaptor plate)
Mounting position	Horizontal Vertical
Width	1.8 in (45 mm)
Height	3.5 in (89 mm)
Depth	3.09 in (78.5 mm)
Net Weight	0.57 lb(US) (0.26 kg)
color	Dark grey

Environment

Standards	EN/IEC 60947-2 EN/IEC 60947-4-1 UL 60947-4-1 CSA C22.2 No 60947-4-1 IEC/EN 60335-2-40:Annex JJ IEC/EN 60335-1:Clause 30.2
Product Certifications	CCC UL CSA EAC ATEX LROS (Lloyds register of shipping) BV RINA DNV-GL UKCA
IK degree of protection	IK04
IP degree of protection	IP20 IEC 60529
Climatic withstand	IACS E10
Ambient Air Temperature for Storage	-40...176 °F (-40...80 °C)
Fire resistance	1760 °F (960 °C) IEC 60695-2-11
Ambient air temperature for operation	-4...140 °F (-20...60 °C)
Mechanical robustness	Shocks 30 Gn for 11 ms Vibrations 5 Gn, 5...150 Hz
Operating altitude	<= 6561.68 ft (2000 m)

Ordering and shipping details

Category	US10I1122367
Discount Schedule	011
GTIN	3389110342970

Returnability	Yes
---------------	-----

Country of origin	TH
-------------------	----

Packing Units

Unit Type of Package 1	PCE
------------------------	-----

Nbr. of units in pkg.	1
-----------------------	---

Package 1 Height	3.150 in (8.000 cm)
------------------	---------------------

Package 1 Width	1.772 in (4.500 cm)
-----------------	---------------------

Package 1 Length	3.543 in (9.000 cm)
------------------	---------------------

Package weight(Lbs)	7.866 oz (223.000 g)
---------------------	----------------------

Unit Type of Package 2	S02
------------------------	-----

Number of Units in Package 2	24
------------------------------	----

Package 2 Height	5.906 in (15.000 cm)
------------------	----------------------

Package 2 Width	11.811 in (30.000 cm)
-----------------	-----------------------

Package 2 Length	15.748 in (40.000 cm)
------------------	-----------------------

Package 2 Weight	12.632 lb(US) (5.730 kg)
------------------	--------------------------

Unit Type of Package 3	P06
------------------------	-----

Number of Units in Package 3	384
------------------------------	-----

Package 3 Height	29.528 in (75.000 cm)
------------------	-----------------------

Package 3 Width	23.622 in (60.000 cm)
-----------------	-----------------------

Package 3 Length	31.496 in (80.000 cm)
------------------	-----------------------

Package 3 Weight	223.769 lb(US) (101.500 kg)
------------------	-----------------------------

Contractual warranty

Warranty (in months)	18
----------------------	----



Environmental Data

Schneider Electric aims to achieve Net Zero status by 2050 through supply chain partnerships, lower impact materials, and circularity via our ongoing “Use Better, Use Longer, Use Again” campaign to extend product lifetimes and recyclability.

[Environmental Data explained >](#)

[How we assess product sustainability >](#)



Environmental footprint

Carbon footprint (kg CO2 eq, Total Life cycle) 43

Environmental Disclosure [Product Environmental Profile](#)

Use Better



Materials and Substances

Packaging made with recycled cardboard Yes

Packaging without single use plastic Yes

[EU RoHS Directive](#) Compliant with Exemptions

SCIP Number 04104e70-ba29-493c-b2cc-b5837d1f879b

REACH Regulation [REACH Declaration](#)

California proposition 65 **WARNING:** This product can expose you to chemicals including: Antimony oxide & Antimony trioxide, which is known to the State of California to cause cancer. For more information go to www.P65Warnings.ca.gov

Use Longer



Lifetime extension

Repair No

Use Again



Repack and remanufacture

Circularity Profile [End of Life Information](#)

Take-back No

WEEE Label  The product must be disposed on European Union markets following specific waste collection and never end up in rubbish bins.

Performance Curves

Thermal-Magnetic Tripping Curves for GV2ME and GV2P
 Average Operating Times at 20 °C Related to Multiples of the Setting Current

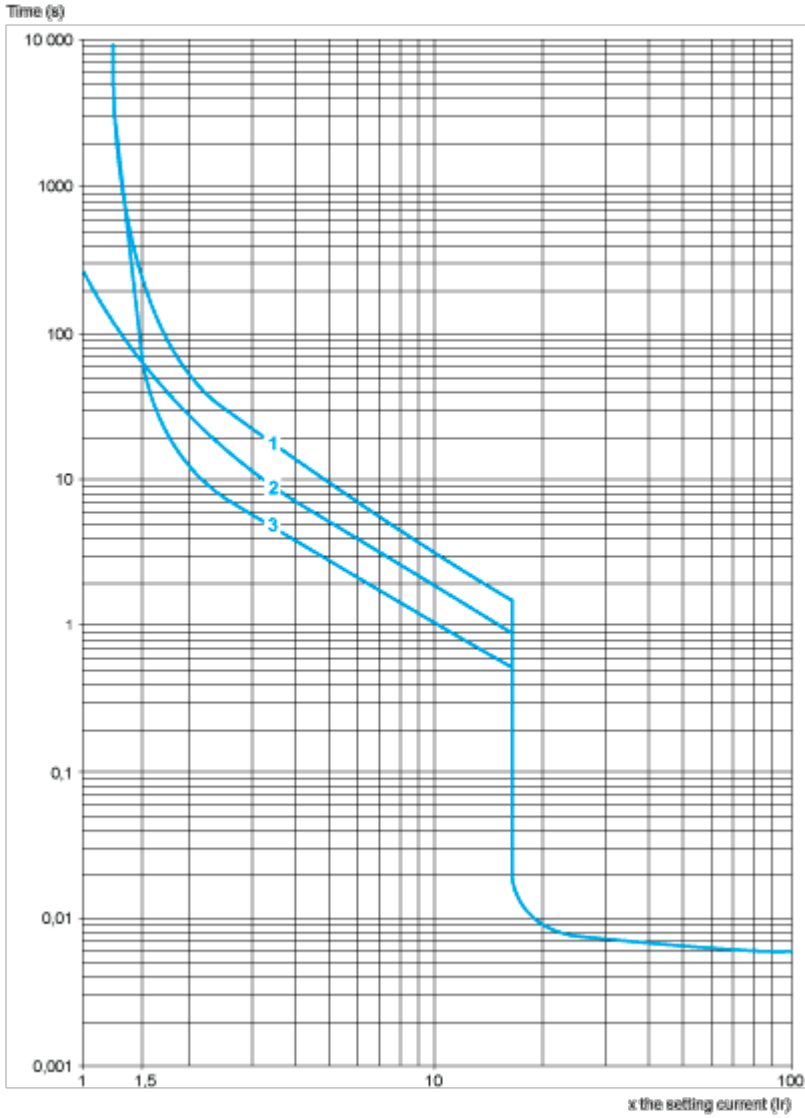

- 1 3 poles from cold state
- 2 2 poles from cold state
- 3 3 poles from hot state

Current Limitation on Short-Circuit for GV2ME and GV2P (3-Phase 400/415 V)

Dynamic Stress

$I_{peak} = f(\text{prospective } I_{sc}) \text{ at } 1.05 U_e = 435 \text{ V}$

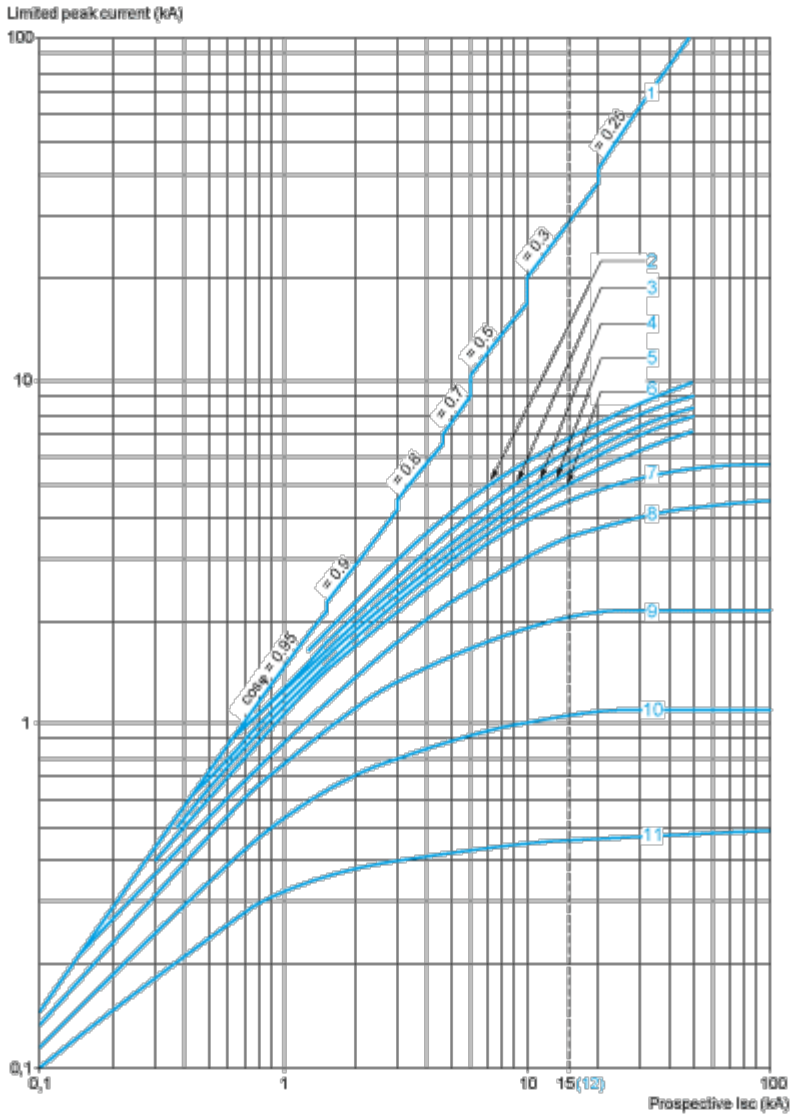

- 1 Maximum peak current
- 2 24-32 A
- 3 20-25 A
- 4 17-23 A
- 5 13-18 A
- 6 9-14 A
- 7 6-10 A
- 8 4-6.3 A
- 9 2.5-4 A
- 10 1.6-2.5 A
- 11 1-1.6 A
- 12 Limit of rated ultimate breaking capacity on short-circuit of GV2ME (14, 18, 23, and 25 A ratings).

Thermal Limit on Short-Circuit for GV2ME

Thermal Limit in kA^2s in the Magnetic Operating Zone

Sum of $I^2dt = f$ (prospective Isc) at 1.05 Ue = 435 V

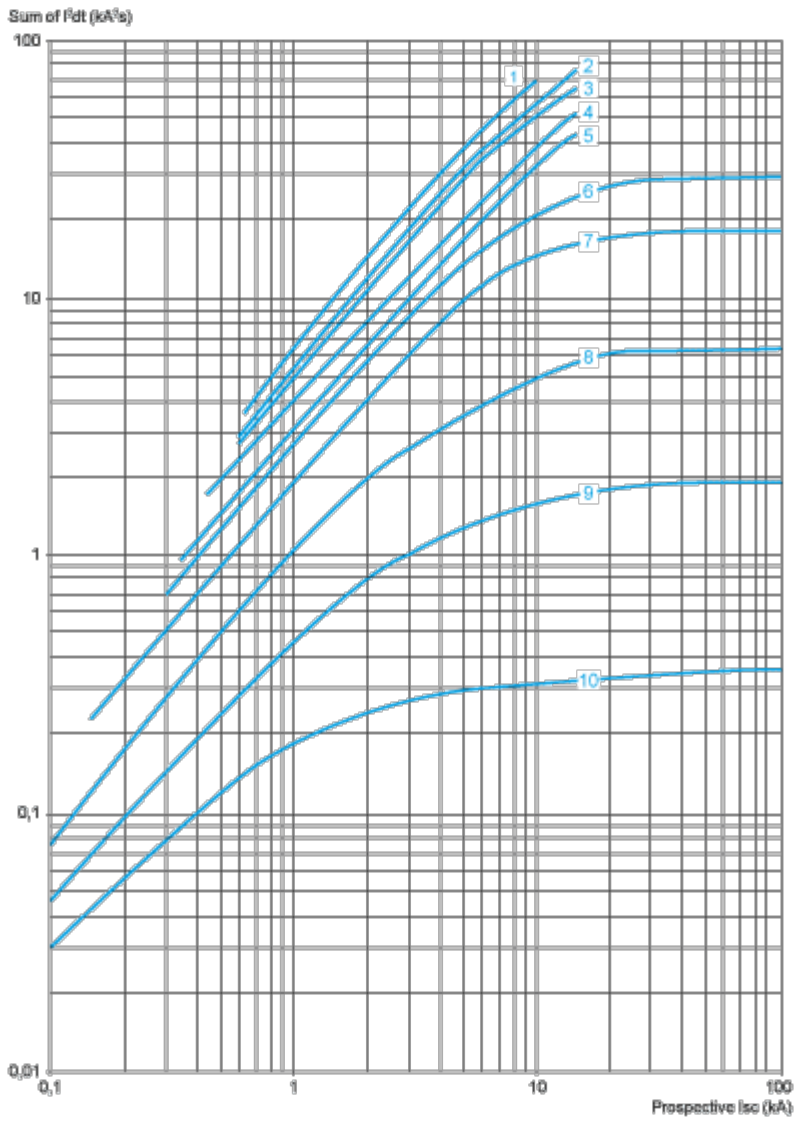

- 1 24-32 A
- 2 20-25 A
- 3 17-23 A
- 4 13-18 A
- 5 9-14 A
- 6 6-10 A
- 7 4-6.3 A
- 8 2.5-4 A
- 9 1.6-2.5 A
- 10 1-1.6 A

Dimensions Drawings

Dimension

GV2ME

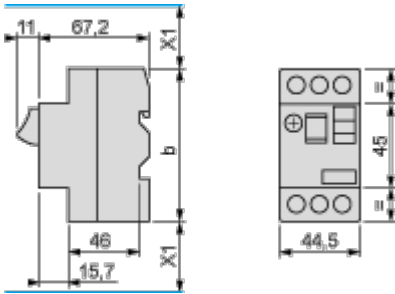

(1) Maximum

X1 Electrical clearance = 40 mm for $U_e \leq 690$ V

	b
GV2ME $\bullet\bullet$	89
GV2ME $\bullet\bullet$ 3	101

Mounting

GV2ME

On 35 mm rail

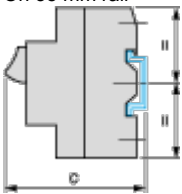

c = 78.5 on AM1 DP200 (35 x 7.5)

c = 86 on AM1 DE200, ED200 (35 x 15)

On panel with adapter plate GV2AF02

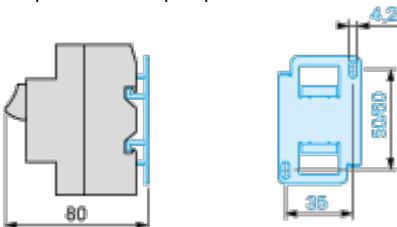

On pre-slotted plate AM1 PA

AF1 EA4

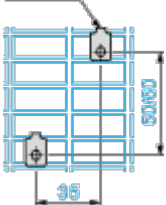

On rails DZ5 MB201

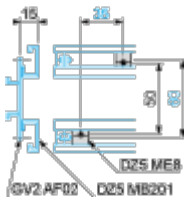

GV2AF01

Combination GV2ME + TeSys k contactor

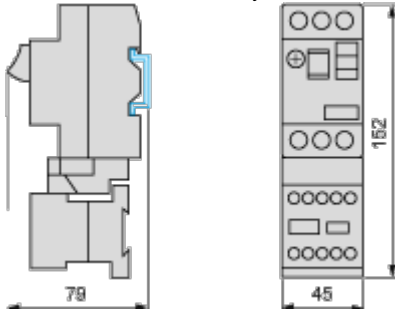

GV2AF3

Combination GV2ME + TeSys d contactor

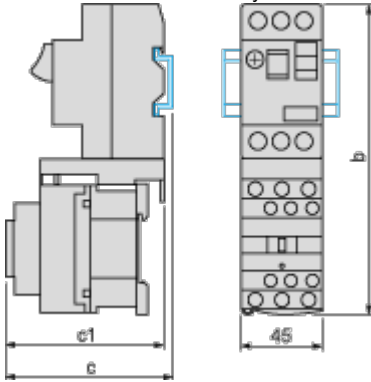

GV2ME +	LC1D09...D18	LC1D25 and D32
b	176.4	186.8
c1	94.1	100.4
c	99.6	105.9

GV2AF4 + LAD311

Combination GV2ME + TeSys d contactor

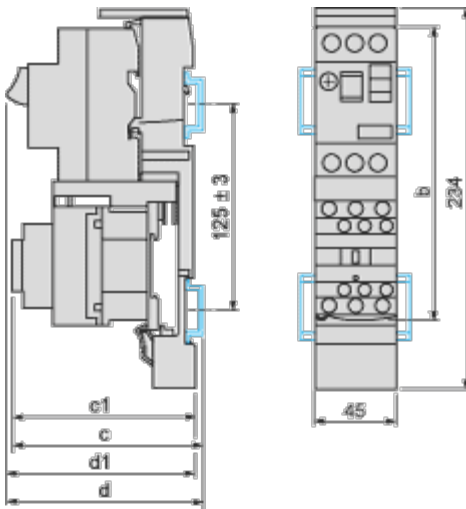

GV2ME +	LC1D09...D18	LC1D25 and D32
b	176.4	186.8
c1	103.1	136.4
c	135.6	141.9
d1	107	107
d	112.5	112.5

GV2ME + GV1L3 (Current Limiter)

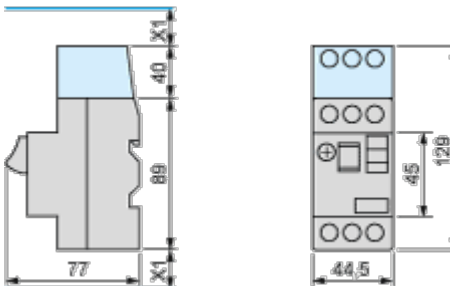

X1 = 10 mm for Ue = 230 V or 30 mm for 230 V < Ue ≤ 690 V

Connections and Schema

GV2ME•• and GV2RT

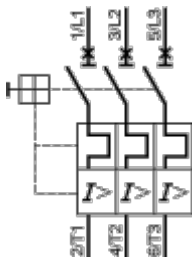

Connection of Undervoltage Trip for Dangerous Machines (Conforming to INRS) on GV2ME Only

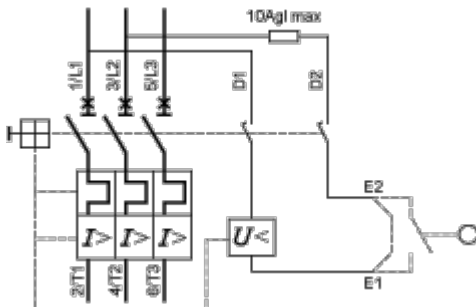

Technical Illustration

Dimensions

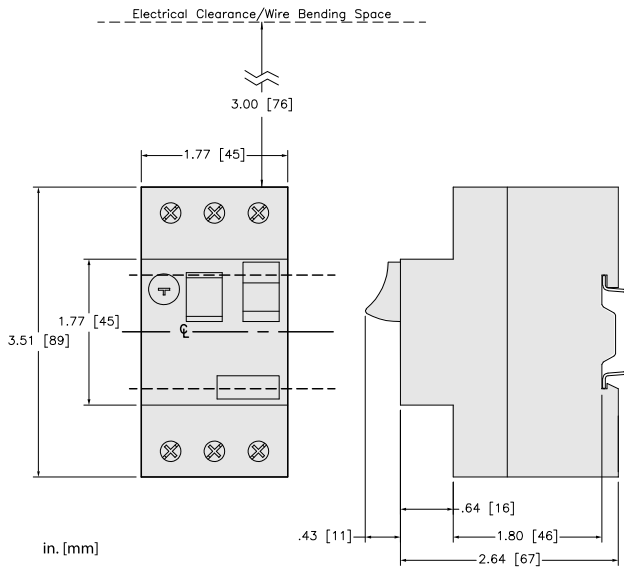

Technical Illustration

Wiring diagram

GV2ME02

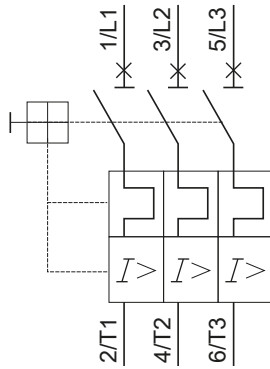

REFER TO TECHNICAL DRAWINGS AND DOCUMENTATION FOR COMPLETE INFORMATION.

Offer Marketing Illustration

Product benefits / Features

TeSys Deca Motor Circuit Breakers

Technical Benefits



- High breaking capacity up to 100 kA.
- Screw clamp for the connection, with lug and spring terminals.
- Easily identify the tripped breaker.
- Padlockable in all versions.
- Sealable thermal overload settings without additional accessories.
- Short circuit indication for better diagnostics when a trip occurs.
- Maximum 15 current ratings to cover from 0.1 A to 32 A motor current with a IP20 level for finger safety.

Offer Marketing Illustration

Product benefits / Features



TeSys Deca Motor Circuit Breakers
Range Accessories

Energy Sensor

Mounting and adapters

Terminal block

Combination block

Motor starter adapter plate

Current limiter

Comb busbar

Auxiliary contact blocks

The image displays a collection of accessories for TeSys Deca Motor Circuit Breakers. At the top left, a large black circuit breaker is shown against a green circular background. Below it, eight different accessory components are arranged in two rows of four. Each component is accompanied by a small text label identifying it: Energy Sensor, Mounting and adapters, Terminal block, Combination block, Motor starter adapter plate, Current limiter, Comb busbar, and Auxiliary contact blocks.

Offer Marketing Illustration

Product benefits / Features



The image shows a TeSys Deca Motor Circuit Breaker, a black rectangular device with a red handle. It has three terminals at the top labeled 1, 2, and 3, and three terminals at the bottom labeled 2, 4, and 6. The handle is in the 'OFF' position. The device is set against a green circular background.

TeSys Deca Motor Circuit Breakers

Technical Benefits

- High breaking capacity up to 100 kA.
- Screw clamp for the connection, with lug and spring terminals.
- Easily identify the tripped breaker.
- Padlockable in all versions.
- Sealable thermal overload settings without additional accessories.
- Short circuit indication for better diagnostics when a trip occurs.
- Maximum 15 current ratings to cover from 0.1 A to 32 A motor current with a IP20 level for finger safety.

Offer Marketing Illustration

Product benefits / Features

TeSys Deca Motor Circuit Breakers



Universal Integration

Can be used for all type of applications across industry, infrastructure and buildings.



Complete protection

Provide short circuit protection, overload protection, motor (ON/OFF) control, all in a single product.



Standard Sync

Compliant to motor control and protection, in accordance with standards.



Offer Marketing Illustration

Product benefits / Features



TeSys Deca Motor Circuit Breakers

Range Accessories



Energy Sensor



Mounting and adapters



Terminal block

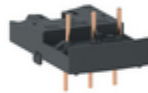

Combination block



Motor starter adapter plate



Current limiter



Comb busbar



Auxiliary contact blocks

Offer Marketing Illustration

Product benefits / Features

TeSys Deca Motor Circuit Breakers



Universal Integration

Can be used for all type of applications across industry, infrastructure and buildings.



Complete protection

Provide short circuit protection, overload protection, motor (ON/OFF) control, all in a single product.



Standard Sync

Compliant to motor control and protection, in accordance with standards.



Image of product / Alternate images

Alternative

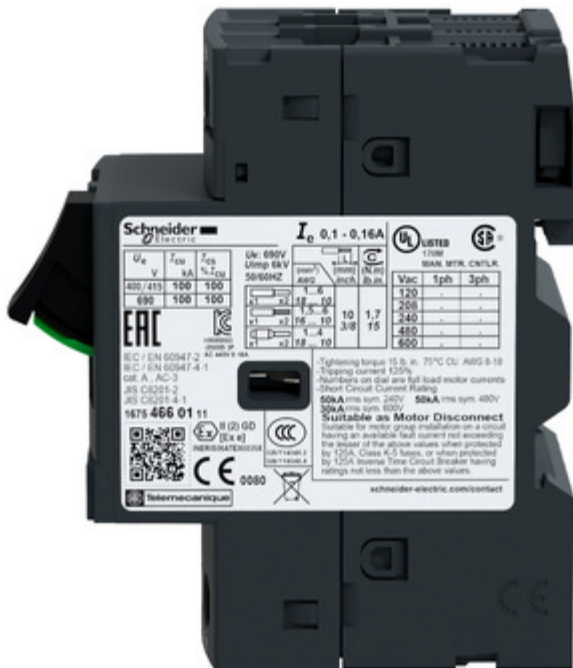
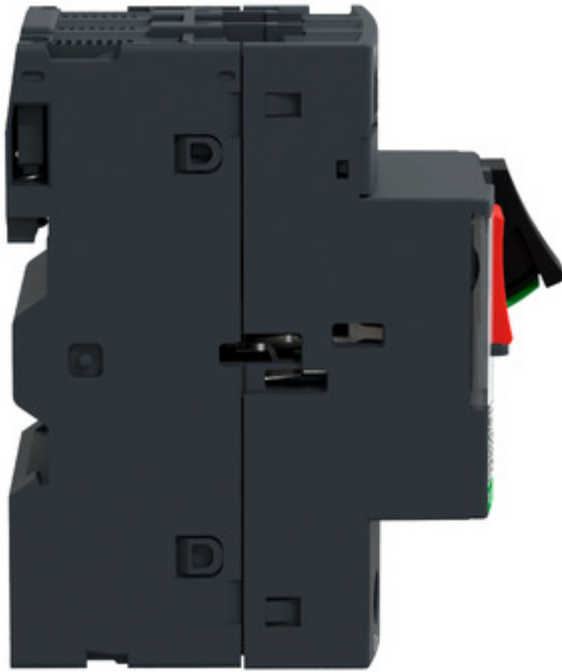

Schneider Electric

I_e 0,1 - 0,16A

UL LISTED 17000
SEAN MET. CNTLR.

U _e V	I _{cu} kA	I _{cs} kA	U _{imp} 6kV	50/60Hz	1.1L mm ²	1.1S mm ²	1.1M mm ²	1.1H mm ²	1.1E mm ²	V _{ac}	3ph	3ph
400/415	100	100			1.6	1.6	1.6	1.6	1.6	120	-	-
480	100	100			1.6	1.6	1.6	1.6	1.6	208	-	-
480	100	100			1.6	1.6	1.6	1.6	1.6	240	-	-
					1.6	1.6	1.6	1.6	1.6	480	-	-
					1.6	1.6	1.6	1.6	1.6	600	-	-

UL: 690V
U_{imp} 6kV
50/60Hz

Lightning torque 15 lb. ft. 70°C CU: 800 8-18
Tripping current 125%

Numbers on dial are full load motor currents
Short Circuit Current Rating:
50kA rms sym 240V 50kA rms sym 480V
30kA rms sym 600V

Suitable as Motor Disconnect
Suitable for motor group installation on a circuit
having an available fault current not exceeding
the lesser of the above values when protected
by 125A Class K-3 fuses, or when protected
by 125A Inverse Time Circuit Breaker having
ratings not less than the above values.

schneider-electric.com/contact

