

VA9300 Series Electric Non-Spring Return Valve Actuators

Product Bulletin

VA9308-AGA-2Z, VA9308-AUA-2Z,
VA9310-AUA-2, VA9310-HGA-2

Code No. LIT-12012265
Issued November 2017

The VA9300 Series Electric Non-Spring Return Actuators are direct mount actuators for valves with ISO Flange mounting such as the VG1000 Series Valves.

The series consists of models with on/off and floating controls as well as models with Automatic Signal Input Detection which allows automatic recognition of input signals for on/off, floating, and proportional control.

An optional line voltage auxiliary switch kit can be field installed to indicate an end-stop position or perform switching functions within the selected rotation range. The VA9300 Actuators also feature a NEMA 4X weathershield for applications in harsh environments.

Figure 1: VA9300 Series Electric Non-Spring Return Actuator



Table 1: Features and Benefits (Part 1 of 2)

Features	Benefits
Models with Automatic Signal Input Detection, On/Off, Floating, and Proportional Control with Adjustable Span and Offset	Increases availability at distributors and simplifies retrofits.
Line Voltage On/Off and Floating Modules	Reduces total installation cost by avoiding the installation of external supply adapters.
High Speed On/Off and Floating Models	Allows applications in loops that require a quick response time.
Easy Conversion to Valve Operation—Same Actuator Used for Dampers or Valves	Increases availability at distributors with only one actuator to learn.
Optional Accessory Kit	Increases availability at distributors. The auxiliary switch kit provides two line-voltage-capable single-pole, double-throw (SPDT) switches with continuously adjustable switch points, and the auxiliary potentiometer kit provides several potentiometer feedback options. Facilitates safety interfacing or signaling.
Backward Compatible Auxiliary Switch Kits and Auxiliary Potentiometer	Allows for a seamless retrofit without the need to replace the controller.
Self-Calibrating Input Signal to Adjust Stroke	Eliminates the need for a complex calibration procedure when adjusting stops.

Table 1: Features and Benefits (Part 2 of 2)

Features	Benefits
Electronic Stall Detection	Protects from overload at all angles of rotation. The actuator may be stalled anywhere in its rotation range without the need for mechanical end switches.
Microprocessor-Controlled Brushless DC Motor	Provides constant runtime independent of torque and increases lifecycle by reducing wear.
Mode Configuration Switches	Permits calibration, input signal range selection, and control logic reversal for proportional control.
Integral Cables with Colored and Numbered Conductors	Simplify installation and field wiring.
Optional Integral 1/2 in. (13 mm) Threaded Conduit Connectors	Simplify installation and field wiring.
Plenum-Rated Models	Enable use in other environmental air spaces (plenums) in accordance with section 300.22(C) of the National Electric Code.
Small Footprint	Allows application in smaller spaces than the M9106/M9109 and M9108 Actuators.
M9106, M9109, and M9108 Series Actuators Replacement	Simplifies product selection and logistics.
Position Indicator Handle	Allows intuitive indication of valve position.
Same Weathershield as VA9203 and VA9208 Series Actuators	Keeps logistics simple and assures quick delivery time.
NEMA5/IP54 Enclosure	Enhances the range of application environments.
Underwriters Laboratories Inc.® (UL), CE Mark, and RCM Compliance	Provides internationally recognized regulatory agency approvals.
Manufactured under International Standards Organization (ISO) 9001 Quality Control Standards	Ensures quality.
100,000 Cycles and 2.5 Million Repositions	Assure long time reliability.
5-Year Warranty	Protects consumer investment.

Product Details

Models with Automatic Input Detection (VA9310-HGA-2)

The actuators operate with AC/DC 24 V to provide 90 lb·in. (10 N·m) rated torque and are designed to be used with on/off, floating, or proportional controls in HVAC. They have a 90-second constant runtime, independent of supply voltage frequency and load. When the actuator is in proportional mode, it responds to DC 0 to 10 V or DC 2 to 10 V control signals. With the addition of a 500 ohm resistor, the actuator responds to a 0 to 20 mA or 4 to 20 mA signal. A DC 0 to 10 V or DC 2 to 10 V feedback signal indicates position. See Figure 2 through Figure 9 for floating and on/off control.

The actuators include plenum-rated cables and are specially configured for installation in spaces used for environmental air-handling purposes, other than ducts and plenums, as specified in National Fire Protection Association (NFPA) 70: National Electrical

Code section 300.22(C), Other Space Used for Environmental Air.

Floating and On/Off Models for Line Voltage (AC 85 to 264 V) for Standard Speed (VA9310-AUA-2)

The actuators have a 90-second constant runtime, independent of supply voltage frequency and load and they provide 90 lb·in. (10 N·m) rated torque. They are designed to be used with on/off or floating controls in HVAC systems. The actuators include halogen free appliance cable.

Floating and On/Off Models for AC/DC 24 V for High Speed (VA9308-AUA-2Z)

The actuators have an 8-second constant runtime, independent of supply voltage frequency and load and they provide 70 lb·in. (8 N·m) rated torque. They are designed to be used with on/off or floating controls in HVAC systems. The actuators include halogen free appliance cable.

Floating and On/Off Models for AC/DC 24 V for High Speed (VA9308-AGA-2Z)

The actuators have an 8-second constant runtime, independent of supply voltage frequency. They are designed to be used with on/off or floating controls in HVAC systems. The actuators include plenum-rated cables and are specially configured for installation in spaces used for environmental air-handling purposes, other than ducts and plenums, as specified in National Fire Protection Association (NFPA) 70: National Electrical Code section 300.22(C), Other Space Used for Environmental Air.

VA9308-AGA-2Z Actuators Wiring Diagrams

Figure 2: Floating 24 V Applications

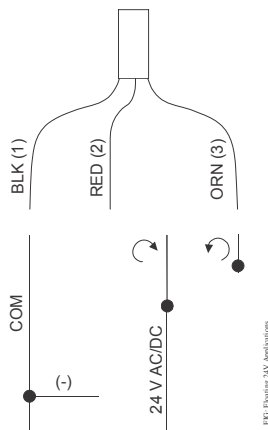
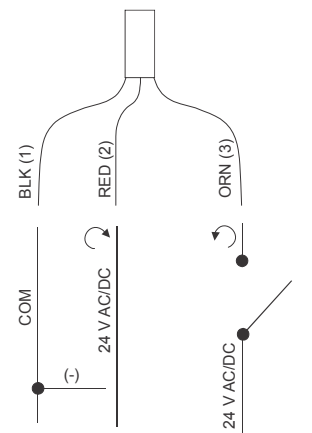

Figure 3: On/Off 24 V Applications



VA9308-AUA-2Z and VA9310-AUA-2 Actuators Wiring Diagrams

Figure 4: Floating 85 to 264 V Applications

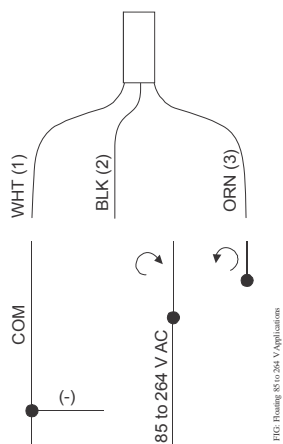
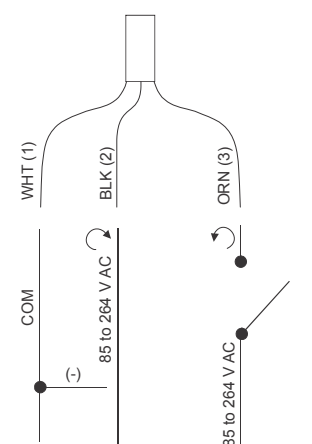

Figure 5: On/Off 85 to 264 V Applications



VA9310-HGA-2 Actuator Wiring Diagrams

Figure 6: Floating 24 V Applications

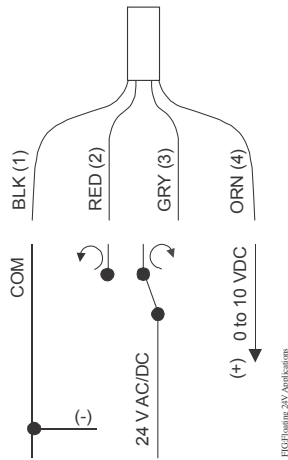

Figure 8: Proportional 24 V Applications

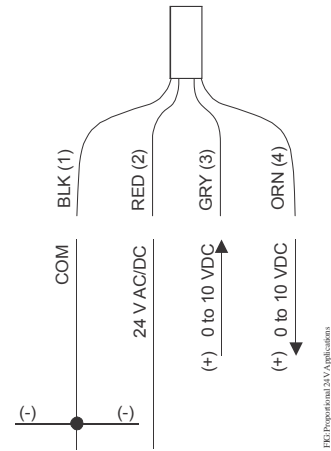

Figure 7: On/Off 24 V Applications

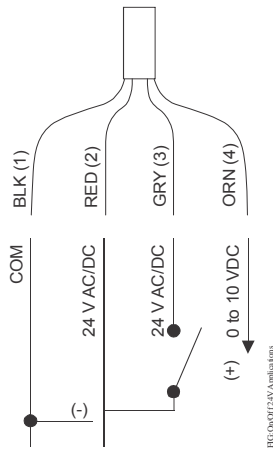
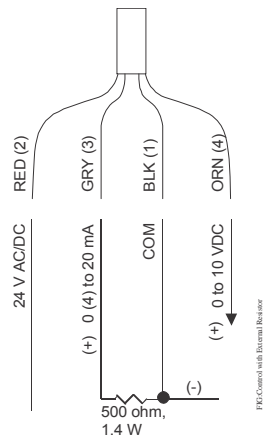

Figure 9: Proportional 24 V Applications - 0 (4) to 20 mA with External Resistor



IMPORTANT: Use this VA9300 Series Electric Non-Spring Return Valve Actuator only to control equipment under normal operating conditions. Where failure or malfunction of the electric actuator could lead to personal injury or property damage to the controlled equipment or other property, additional precautions must be designed into the control system. Incorporate and maintain other devices, such as supervisory or alarm systems or safety or limit controls, intended to warn of or protect against failure or malfunction of the electric actuator.

IMPORTANT : Utiliser ce VA9300 Series Electric Non-Spring Return Valve Actuator uniquement pour commander des équipements dans des conditions normales de fonctionnement. Lorsqu'une défaillance ou un dysfonctionnement du electric actuator risque de provoquer des blessures ou d'endommager l'équipement contrôlé ou un autre équipement, la conception du système de contrôle doit intégrer des dispositifs de protection supplémentaires. Veiller dans ce cas à intégrer de façon permanente d'autres dispositifs, tels que des systèmes de supervision ou d'alarme, ou des dispositifs de sécurité ou de limitation, ayant une fonction d'avertissement ou de protection en cas de défaillance ou de dysfonctionnement du electric actuator.

Operation

VA9300 Series Actuators use a brushless DC motor controlled by a microprocessor. The microprocessor drives the motor at constant speed, independent of torque. The actuator slows down before it reaches its stop position minimizing the impact on the gearbox, further reducing gear wear. The microprocessor also monitors the brushless DC motor's rotation to prevent damage to the actuator in a stall condition. The actuator can be stalled anywhere within its rotation range without the need for mechanical end switches.

Auto-Calibration Mode (VA9310-HGA-2)

The actuator self-calibrates the control signal when an end stop is adjusted on the stroke. An auto-calibration has to be performed to change the feedback of the actuator. The auto-calibration mode identifies the available range of travel of the coupler. During the auto-calibration mode, the actuator moves the coupler to the maximum and minimum end stops to identify the range of travel.

DIP Switches and Status LEDs

The actuators allow easy setting of the input signals. Through the DIP switches located under the removable oval cover in the front of the unit, it is possible to set reverse or direct acting and to select 0 to 10 V or 2 to 10 V input or other starting points and spans. See Figure 10 and Table 2.

Figure 10: DIP Switches and LEDs

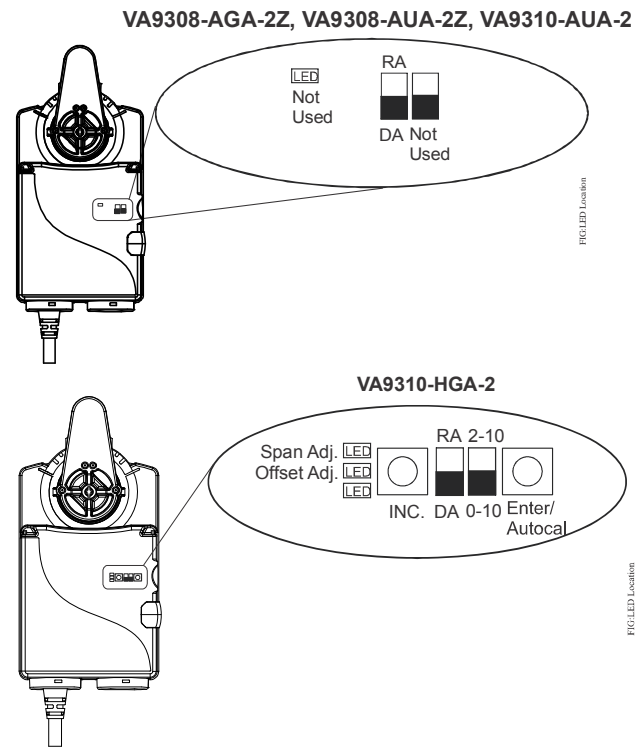

Table 2: DIP Switch Settings for VA9308-AGA-2Z, VA9308-AUA-2Z, VA9310-AUA-2

Command Signal	Feedback Signal	Settings for User Interface
Floating or On/Off	Direct	<input type="checkbox"/> Not Used RA <input type="checkbox"/> <input checked="" type="checkbox"/> DA <input checked="" type="checkbox"/> <input checked="" type="checkbox"/> Not Used
Floating or On/Off	Reverse	<input type="checkbox"/> Not Used RA <input checked="" type="checkbox"/> <input checked="" type="checkbox"/> DA <input checked="" type="checkbox"/> <input checked="" type="checkbox"/> Not Used

Table 3: DIP Switch Settings for VA9310-HGA-2

Example	Command Signal	Feedback Signal	Settings for User Interface
1	DC 0 to 10 V	Direct DC 0 to 10 V	<input type="checkbox"/> <input type="checkbox"/> <input type="checkbox"/> <input checked="" type="checkbox"/> <input checked="" type="checkbox"/> RA 2-10 <input checked="" type="checkbox"/> <input checked="" type="checkbox"/> DA 0-10
2	DC 0 to 10 V	Reverse DC 0 to 10 V	<input type="checkbox"/> <input type="checkbox"/> <input type="checkbox"/> <input checked="" type="checkbox"/> <input checked="" type="checkbox"/> RA 2-10 <input checked="" type="checkbox"/> <input checked="" type="checkbox"/> DA 0-10

Table 3: DIP Switch Settings for VA9310-HGA-2

Example	Command Signal	Feedback Signal	Settings for User Interface
3	DC 2 to 10 V	Direct DC 2 to 10 V	
	AC 24 V	—	
4	Offset = 5 Span = 7	Reverse DC 10 to 2 V	

Figure 11: Graphed Examples of Table 3 Command Signals

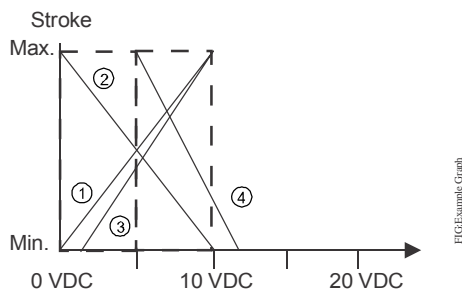

Ordering Information

Table 4: Selection Chart

Code Number	Rotation Time For 90°	Power Supply		Input Signal			Position Feedback				Electrical Connection		Auxiliary Switches		
	Running (Seconds)	AC/DC 24 V	AC 85 to 264 V	On/Off	Floating	Proportional DC 0 (2) to 10 V (with Adjustable Span)	DC 0 (2) to 10 V	140 Ω	1 k Ω	2 k Ω	10 k Ω	120 in. (3 m) Plenum Cable	48 in. (1 m) Halogen Free Cable	1 x SPDT, 3 (0.5) A, AC 240 V	2 x SPDT, 3 (0.5) A, AC 240 V
VA9308-AGA-2Z ¹	8	X		X	X			X ²	X ²	X ²	X ²	X		X ³	X ³
VA9308-AUA-2Z ¹	8		X	X	X			X ²	X ²	X ²	X ²		X	X ³	X ³
VA9310-AUA-2 ¹	90		X	X	X			X ²	X ²	X ²	X ²		X	X ³	X ³
VA9310-HGA-2	90	X		X	X	X	X ⁴	X ²	X ²	X ²	X ²	X		X ³	X ³

1. Only available for field mounting onto VG1000 Series Valves.
2. With optional external feedback potentiometer kit (M9300-140, M9300-1K, M9300-2K, or M9000-10K)
3. With optional external auxiliary switch kit (M9300-1 or M9300-2).
4. Feedback is available when 0 (2) to 10 V proportional input is used.

Mounting Options

VA9300 Series Actuators are mounted directly to the valve or with the M9000-561 Thermal Barrier when the high temperature fluid or low pressure steam are used or additional spacing for insulation is needed.

VA9310 Series Actuators can be easily converted into M9310 Series Actuators using the M9310-600 Coupler.

Optional External Switch Kit

For control requiring line-voltage-capable switches, an optional switch kit can couple to the actuator. The switch kit provides independent and continuously adjustable switch points throughout the full range of the actuator stroke. Auxiliary switches are double insulated so an electrical ground is not required.

Optional External Potentiometer Kit

For control requiring potentiometer feedback, the optional external potentiometer kit can couple to the actuator. The potentiometer kit provides a resistive signal proportional to the degree of rotation.

Table 5: Accessories (Order Separately)

Code Number	Description
M9000-342	NEMA 4X, IP66/67 weathershield kit for VG1000 Series Ball application of VA9104, VA9310, VA9203, and VA9208 Series Electric Actuators (quantity 1)
M9000-561	Thermal barrier kit, extends the VA9104, VA9310, VA9203, and VA9208 Series Electric Actuators applications to include low pressure steam
M9300-1	External auxiliary switch kit (one single-pole, double-throw)
M9300-2	External auxiliary switch kit (two single-pole, double-throw)
M9300-100	Threaded conduit adapters for 1/2 in. electrician's fittings (quantity 5)
M9300-140	External auxiliary feedback potentiometer 140k ohm
M9300-1K	External auxiliary feedback potentiometer 1k ohm
M9300-2K	External auxiliary feedback potentiometer 2k ohm
M9300-10K	External auxiliary feedback potentiometer 10k ohm
M9310-600	Standard coupler kit, M9310 Series (round 3/8 in. to 3/4 in. [9 mm to 19 mm]) (square 3/8 in. to 5/8 in. [9 mm to 16 mm])
M9000-700	Universal Ball Valve Linkage Kit

**Figure 13: VA9300 Series Electric Non-Spring Return Actuator and Valve Dimensions
(with Optional M9000-561 Thermal Barrier and M9300-2 Switch Kit)**

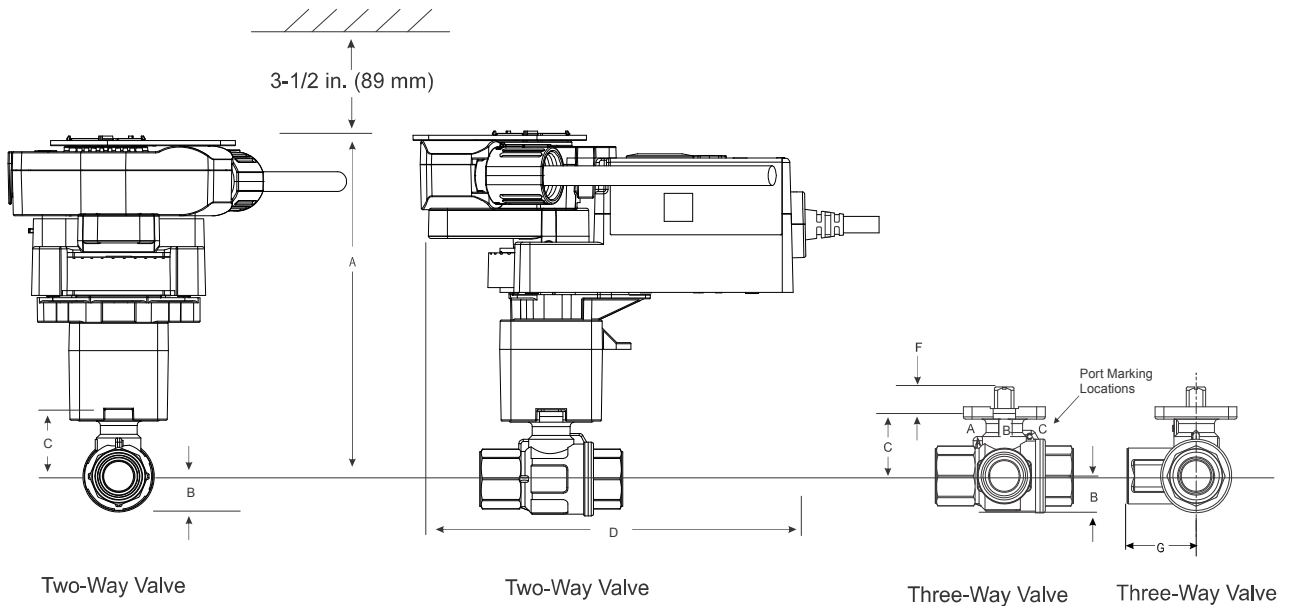

**Table 7: VA9300 Actuated VG1241, VG1245, VG1841, and VG1845 Series Ball Valve Dimensions
(with Optional M9000-561 Thermal Barrier and M9300-2 Switch Kit)**

Valve Size, in. (DN)	A (With Thermal Barrier)	A (Without Thermal Barrier)	B	C	D	E	F	G
1/2 (DN15)	6-3/25 (155.7)	4-3/4 (120.7)	21/32 (17)	1-7/32 (31)	6-21/32 (169)	2-33/64 (64)	11/32 (9)	1-1/4 (32)
3/4 (DN20)	6-3/25 (155.7)	4-3/4 (120.7)	21/32 (17)	1-7/32 (31)	6-21/32 (169)	2-51/64 (71)	11/32 (9)	1-13/32 (36)
1 (DN25)	6-1/5 (157.7)	4-21/25 (122.7)	3/4 (19)	1-5/16 (33)	6-21/32 (169)	3-13/32 (87)	11/32 (9)	1-45/64 (43)
1-1/4 (DN32)	6-16/25 (168.7)	5-1/4 (133.7)	1-1/32 (26)	1-23/32 (44)	6-21/32 (169)	3-15/16 (100)	11/32 (9)	1-31/32 (50)
1-1/2 (DN40)	6-4/5 (172.7)	5-3/7 (137.7)	1-1/8 (29)	1-7/8 (48)	6-21/32 (169)	4-21/64 (110)	11/32 (9)	2-11/64 (55)
2 (DN50)	6 (177.2)	5-5/8 (142.7)	1-15/32 (37)	2-1/16 (53)	6-21/32 (169)	4-27/32 (123)	11/32 (9)	2-27/64 (62)

Technical Specifications

VA9308-AxA-2Z and VA9310-AUA-2 Series Electric Non-Spring Return Actuators

Product Description	VA9308-AGA-2Z: Floating and on/off mode	VA9308-AUA-2Z: Floating and on/off mode	VA9310-AUA-2: Floating and on/off mode
Power Requirements	AC 24 V \pm 20% at 50/60 Hz, Class 2 (North America) or SELV (Europe), 12.7 VA running. DC 24 V \pm 10% Class 2 (North America) or SELV (Europe), 5.7 W running.	Nominal AC 120 V at 60 Hz: 0.07 A running, 0.02 A holding position	Nominal AC 120 V at 60 Hz: 0.04 A running, 0.02 A holding position
Transformer Sizing Requirements	\geq 13 VA	—	—
Input Signal/Adjustments	AC 19.2 to 28.8 V at 50/60 Hz or DC 24 V \pm 10% Class 2 (North America) or SELV (Europe)	AC 100 to 240 V (AC 85 to 264 V) at 50/60 Hz	
Rotation Range	Mechanically limited to 95° \pm 3°		
Rotation Time for 90° of Travel	8 sec, constant at all operating conditions		90 sec, constant at all operating conditions
Cycles	60,000 full stroke cycles; 1,500,000 repositions		100,000 full stroke cycles; 2,500,000 repositions
Audible Noise	<52 dBA at 0 to 70 lb·in (8 N·m) load, at a distance of 39-13/32 in. (1m)		<35 dBA at 39-13/32 in. (1m)
Electrical Connections	120 in. (3.05 m) UL 444 type CMP plenum rated cable with 19 AWG (0.75 mm ²) conductors and 0.25 in. (6 mm) ferrule ends	48 in. (1.2 m) halogen free cable with 18 AWG (0.82 mm ²) conductors and 0.25 in. (6mm) ferrule ends	
Conduit Connections	1/2 in. NPSM (13 mm) threaded conduit connectors with M9300-100 Conduit Connector (optional with the VA9308-AGA-2Z)		
Ambient Conditions	Operating: -22 to 140°F (-30 to 60°C), 95% RH, noncondensing Storage: -40 to 185°F (-40 to 85°C), 95% RH, noncondensing		
Fluid Temperature Limits (Actuator and Valve Assembly)	VG12x1 and VG18x1 Series: 23 to 203°F (-5 to 95°C) VG12x5 and VG18x5 Series: -22 to 212°F (-30 to 100°C) VG12x5 and VG18x5 Series with M9000-561 Thermal Barrier Installed: -22 to 284°F (-30 to 140°C) water; 15 psig (103 kPa) at 250°F (121°C) saturated steam		
Enclosure	IP54/NEMA 5		
Shipping Weight	2 lb (0.9 kg)		
Compliance	<p>United States: UL Listed, CCN XAPX, File E27734; to UL 60730-1: Automatic Electrical Controls for Household and Similar Use, Part 1; and UL 60730-2-14: Part 2, Particular Requirements for Electric Actuators. Plenum Rated (UL 2043). Suitable for use in Other Environmental Air Space (Plenum) in accordance with section 300.22 (c) of the National Electrical Code.</p> <p>Canada: UL Listed, CCN XAPX7, File E27734; to CAN/CSA E60730-1:02: Automatic Electrical Controls for Household and Similar Use, Part 1; and CAN/CSA-E60730-2-14, Particular Requirements for Electric Actuators.</p> <p>Europe: CE Mark—Johnson Controls declares that this product is in compliance with the essential requirements and other relevant provisions of the EMC Directive and the Low Voltage Directive.</p> <p>Australia and New Zealand: RCM Mark, Australia/NZ Emissions Compliant</p>		

VA9310-HGA-2 Electric Non-Spring Return Actuator

Product Description	VA9310-HGA-2: On/off and floating mode	VA9310-HGA-2: Proportional mode
Power Requirements	AC 24 V $\pm 20\%$ at 50/60 Hz, Class 2 (North America) or SELV (Europe), 4.7 VA running. DC 24 V $\pm 10\%$ Class 2 (North America) or SELV (Europe), 1.3 W running.	
Transformer Sizing Requirements	≥ 6 VA	
Input Signal/Adjustments	AC 19.2 to 28.8 V at 50/60 Hz or DC 24 V $\pm 10\%$ Class 2 (North America) or SELV (Europe)	DC 0 (2) to 10 V or 0 (4) to 20 mA with field furnished 500 ohm 1/4 W resistor Offset: DC 0 to 10 V SPAN: DC 2 to 10 V
Control Impedance	4.7k ohm	100k ohm
Feedback Signal	—	DC 0 (2) to 10 V
Rotation Range	Mechanically limited to $95^\circ \pm 3^\circ$	
Rotation Time for 90° of Travel	90 seconds, constant for all operating conditions	
Rotation Time Auto-calibration	35 seconds	
Cycles	100,000 full stroke cycles; 2,500,000 repositions	
Audible Noise	<35 dBA at 0 to 90 lb·in (10 N·m) load, at a distance of 39-13/32 in. (1 m)	
Electrical Connections	120 in. (3.05 m) UL 444 type CMP plenum rated cable with 19 AWG cable (0.75 mm ²) conductors and 0.25 in. (6 mm) ferrule ends	
Conduit Connections	1/2 in. NPSM (13 mm) threaded conduit connectors with M9300-100 Conduit Connector (optional with the M9310-HGA-2)	
Ambient Conditions	Operating: -22 to 140°F (-30 to 60°C), 95% RH, noncondensing Storage: -40 to 185°F (-40 to 85°C), 95% RH, noncondensing	
Fluid Temperature Limits (Actuator and Valve Assembly)	VG12x1 and VG18x1 Series: 23 to 203°F (-5 to 95°C) VG12x5 and VG18x5 Series: -22 to 212°F (-30 to 100°C) VG12x5 and VG18x5 Series with M9000-561 Thermal Barrier Installed: -22 to 284°F (-30 to 140°C) water; 15 psig (103 kPa) at 250°F (121°C) saturated steam	
Enclosure	IP54/NEMA 5	
Shipping Weight	2 lb (0.9 kg)	
Compliance	<p>United States: UL Listed, CCN XAPX, File E27734; to UL 60730-1: Automatic Electrical Controls for Household and Similar Use, Part 1; and UL 60730-2-14: Part 2, Particular Requirements for Electric Actuators. Plenum Rated (UL 2043). Suitable for use in Other Environmental Air Space (Plenum) in accordance with section 300.22 (c) of the National Electrical Code.</p> <p>Canada: UL Listed, CCN XAPX7, File E27734; to CAN/CSA E60730-1:02: Automatic Electrical Controls for Household and Similar Use, Part 1; and CAN/CSA-E60730-2-14, Particular Requirements for Electric Actuators.</p> <p>Europe: CE Mark—Johnson Controls declares that this product is in compliance with the essential requirements and other relevant provisions of the EMC Directive and the Low Voltage Directive.</p> <p>Australia and New Zealand: RCM Mark, Australia/NZ Emissions Compliant</p>	

The performance specifications are nominal and conform to acceptable industry standard. For application at conditions beyond these specifications, consult the local Johnson Controls office. Johnson Controls shall not be liable for damages resulting from misapplication or misuse of its products.



Building Technologies & Solutions
507 E. Michigan Street, Milwaukee, WI 53202

Metasys® and Johnson Controls® are registered trademarks of Johnson Controls.
All other marks herein are the marks of their respective owners. © 2017 Johnson Controls.